

Silicon Epitaxial Planar Transistor

S8050

FEATURES

- High Collector Current.($I_C = 500\text{mA}$).
- Complementary To S8550.
- Excellent H_{FE} Linearity.
- High total power dissipation.($P_C = 300\text{mW}$).

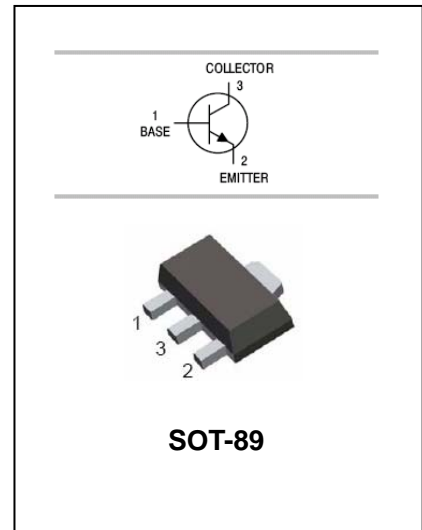

APPLICATIONS

- High Collector Current.

ORDERING INFORMATION

Type No.	Marking	Package Code
S8050	J3Y	SOT-89

MAXIMUM RATING @ $T_a = 25^\circ\text{C}$ unless otherwise specified

Symbol	Parameter	Value	Units
V_{CBO}	Collector-Base Voltage	40	V
V_{CEO}	Collector-Emitter Voltage	25	V
V_{EBO}	Emitter-Base Voltage	5	V
I_C	Collector Current -Continuous	500	mA
P_C	Collector Dissipation	750	mW
T_j, T_{stg}	Junction and Storage Temperature	-55 to +150	$^\circ\text{C}$



Silicon Epitaxial Planar Transistor

S8050

ELECTRICAL CHARACTERISTICS @ Ta=25°C unless otherwise specified

Parameter	Symbol	Test conditions	MIN	TYP	MAX	UNIT
Collector-base breakdown voltage	$V_{(BR)CBO}$	$I_C=100\mu A, I_E=0$	40			V
Collector-emitter breakdown voltage	$V_{(BR)CEO}$	$I_C=0.1mA, I_B=0$	25			V
Emitter-base breakdown voltage	$V_{(BR)EBO}$	$I_E=100\mu A, I_C=0$	5			V
Collector cut-off current	I_{CBO}	$V_{CB}=40V, I_E=0$			0.1	μA
Collector cut-off current	I_{CEO}	$V_{CE}=20V, I_B=0$			0.1	μA
Emitter cut-off current	I_{EBO}	$V_{EB}=5V, I_C=0$			0.1	μA
DC current gain	h_{FE}	$V_{CE}=1V, I_C=50mA$ $V_{CE}=1V, I_C=500mA$	120 50		350	
Collector-emitter saturation voltage	$V_{CE(sat)}$	$I_C=500mA, I_B=50mA$			0.6	V
Base-emitter saturation voltage	$V_{BE(sat)}$	$I_C=500mA, I_B=50mA$			1.2	V
Transition frequency	f_T	$V_{CE}=6V, I_C=20mA$ $f=30MHz$	150			MHz

CLASSIFICATION OF $h_{FE(1)}$

Rank	L	H
Range	120-200	200-350

Silicon Epitaxial Planar Transistor

S8050

TYPICAL CHARACTERISTICS @ Ta=25°C unless otherwise specified

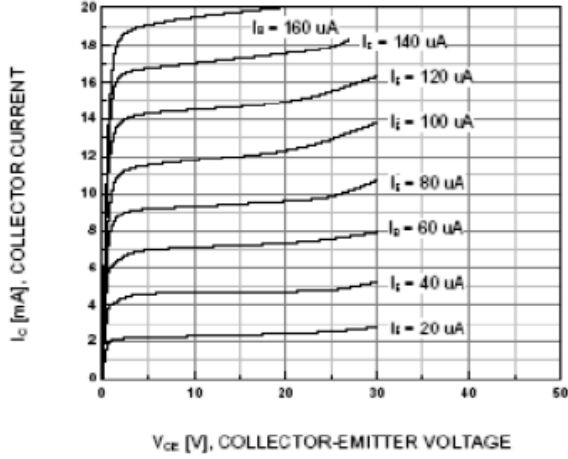

Figure 1. Static Characteristic

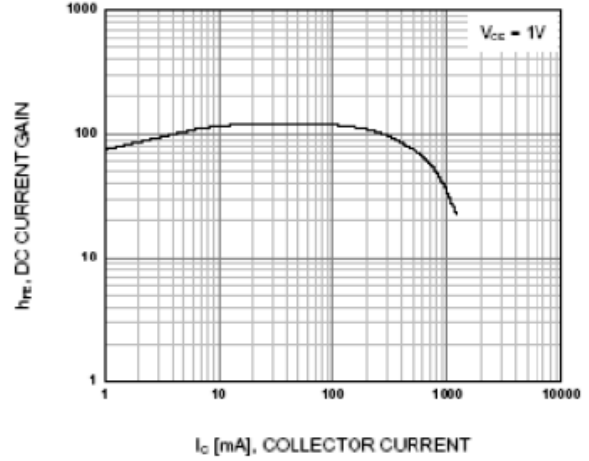

Figure 2. DC current Gain

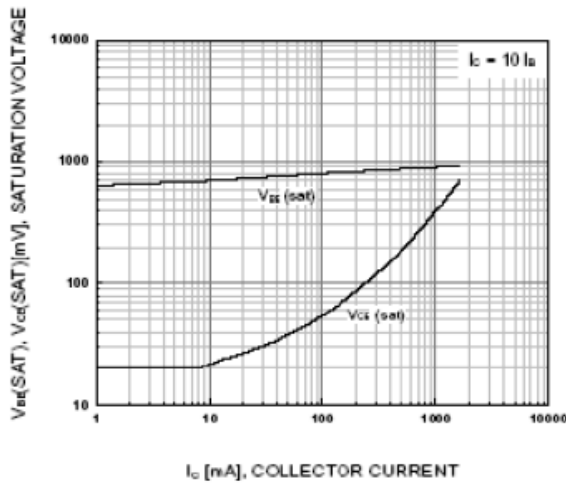

Figure 3. Base-Emitter Saturation Voltage
Collector-Emitter Saturation Voltage

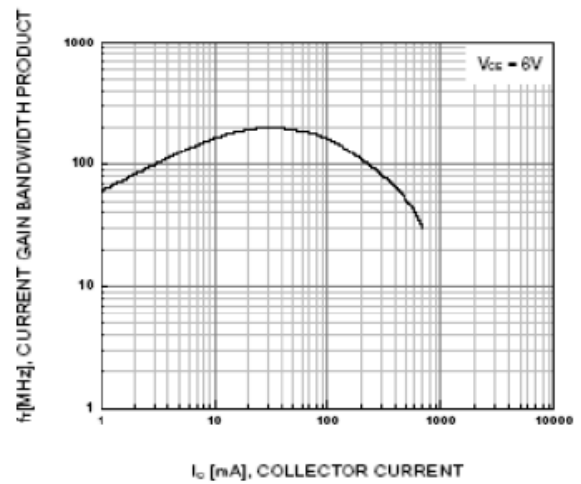

Figure 4. Current Gain Bandwidth Product



Silicon Epitaxial Planar Transistor

S8050

PACKAGE OUTLINE

Plastic surface mounted package

SOT-89

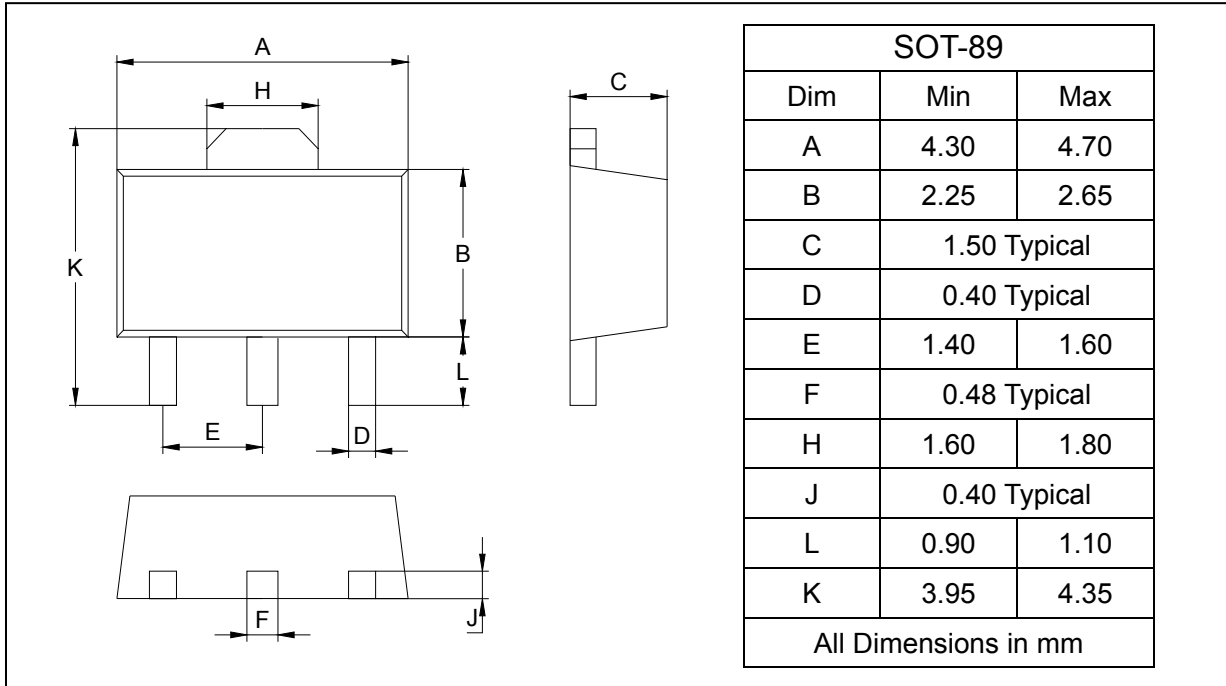

SOLDERING FOOTPRINT

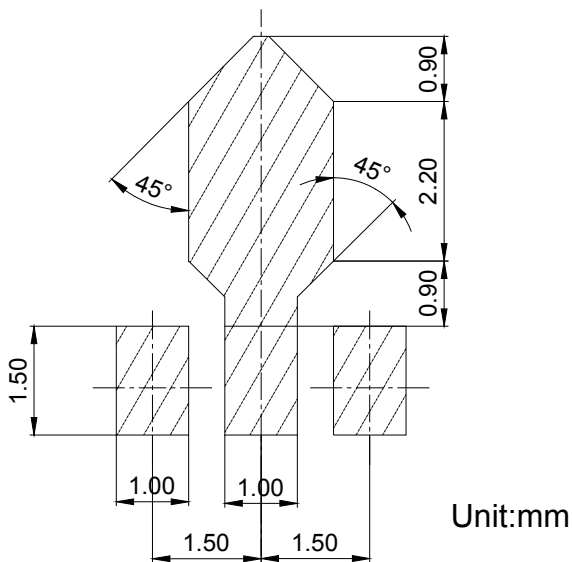

PACKAGE INFORMATION

Device	Package	Shipping
S8050	SOT-89	1000/Tape&Reel